

PROFESSIONAL WEATHER STATION

Operation Manual

Table of Contents

1. Introduction.....	3
2. Warnings and Cautions.....	3
3. Quick Start Guide.....	3
4. Pre-Installation Checkout and Site Survey.....	4
4.1 Pre Installation Checkout.....	4
4.2 Site Survey.....	4
5. Setting Started.....	5
5.1 Contents.....	5
5.2 Sensor Set Up.....	5
5.2.1 Install U-bolts and mounting pole.....	6
5.2.2 Install wind vane.....	7
5.2.3 Install wind speed.....	7
5.2.4 Install Rain Gauge.....	8
5.2.5 Install Batteries.....	8
5.2.6 Mount assembled outdoor sensor package.....	9
5.2.6.1 Before you mount.....	9
5.2.6.2 Mounting.....	9
5.2.7 Reset Button and Transmitter LED.....	10
5.3 Best Practices for Wireless Communication.....	11
5.4 Display console.....	12
5.4.1 Vertical Desk Stand.....	14
6. Display Console Operation.....	15
6.1 Screen Display.....	15
6.2 Initial Display Console Set Up.....	16
6.3 Key function.....	17
6.4 Setting mode.....	18
6.4.1 BEEP:.....	18
6.4.2 MAX/MIN Daily:.....	18
6.4.3 Time / Date.....	18
6.4.4 Pressure.....	19
6.4.5 Light.....	21
6.4.6 Temperature.....	21
6.4.7 Wind speed.....	21
6.4.8 Rain.....	21
6.4.9 Moon phase.....	22

6.5 Alarm mode.....	22
6.5.1 Display of Alarm value.....	22
6.5.2 Alarm mode setting:.....	23
6.5.3 Alarm Setting Order:.....	23
6.6 Max/min mode.....	24
6.6.1 Press and release MAX/MIN key to display MAX data.....	24
6.7 Calibration mode.....	24
6.8 Other Features.....	25
6.8.1 Factory Reset/Clear Memory.....	25
6.8.2 Register New Transmitter.....	25
6.8.3 Backlight Operation.....	26
6.8.4 Tendency indicators.....	26
6.8.5 Wireless Signal Strength Indicator.....	26
6.8.6 Weather forecast.....	27
6.8.7 Snooze.....	28
6.8.8 MAC address display.....	29
7. Specification:.....	30
8. Live Internet Publishing.....	32
8.1 Connecting the Weather Station Console to WiFi.....	33
8.1.1 Download mobile application.....	33
8.1.2 Connect the console to Wi-Fi.....	33
8.1.2.1 Android user:.....	33
8.1.2.2 iOS user:.....	44
8.2 Mobile application – Device list.....	52
8.3 Mobile application – Check WU weather data and graph.....	53
8.4 Mobile application – Remove or Add WU ID.....	54
8.5 Mobile application – Set Units.....	55
9. Registering WeatherUnderground.com through the PC or Mac.....	57
10. Maintenance.....	63
11. Troubleshooting Guide.....	64

1. Introduction

Thank you for your purchase of the Solar Powered Wireless WiFi Weather Station. The following user guide provides step by step instructions for installation, operation and troubleshooting.

2. Warnings and Cautions

 **Warning:** Any metal object may attract a lightning strike, including your weather station mounting pole. Never install the weather station in a storm.

 **Warning:** Installing your weather station in a high location may result in injury or death. Perform as much of the initial check and operation on the ground and inside a building or home. Only install the weather station on a clear, dry day.

3. Quick Start Guide

Although the manual is comprehensive, much of the information contained may be intuitive. In addition, the manual does not flow properly because the sections are organized by components.

The following Quick Start Guide provides only the necessary steps to install, operate the weather station, and upload to the internet, along with references to the pertinent sections.

Required		
Step	Description	Section
1	Assemble and power up the Y shape sensor	5.2.1–5.2.3
2	Power up the display console and synchronize with Y shape sensor	5.4
5	Mount the sensor array	5.2.4
3	Set date and time on console	6.4.5
4	Calibrate the relative pressure to sea-level conditions (local airport) on console	6.4.3
6	Reset the rain to zero on console	6.4.8
Optional		
7	Configure WiFi	8.1
8	Register and upload to Weather Server	9

4. Pre-Installation Checkout and Site Survey

4.1 Pre Installation Checkout

Before installing your weather station in the permanent location, we recommend operating the weather station for one week in a temporary location with easy access. This will allow you to check out all of the functions, insure proper operation, and familiarize you with the weather station and calibration procedures. This will also allow you to test the wireless range of the weather station.

4.2 Site Survey

Perform a site survey before installing the weather station. Consider the following:

1. You must clean the rain gauge every few months and change the batteries every 2-3 years. Provide easy access to the weather station.
2. Avoid radiant heat transfer from buildings and structures. In general, install the sensor array at least 5' from any building, structure, ground, or roof top.
3. Avoid wind and rain obstructions. The rule of thumb is to install the sensor array at least four times the distance of the height of the tallest obstruction. For example, if the building is 20' tall, and the mounting pole is 6' tall, install $4 \times (20 - 6) = 56'$ away.
4. Wireless Range. The radio communication between receiver and transmitter in an open field can reach a distance of up to 100 meters, providing there are no interfering obstacles such as buildings, trees, vehicles, high voltage lines. Wireless signals will not penetrate metal buildings. Under most conditions, the maximum wireless range is 100'.
5. Radio interference such as PCs, radios or TV sets can, in the worst case, entirely cut off radio communication. Please take this into consideration when choosing console or mounting locations. Make sure your display console is at least five feet away from any electronic device to avoid interference.

5. Setting Started

5.1 Contents

QTY	Item
1	Display Console
1	Y shape outdoor sensor(Thermo-hygrometer / Rain Gauge / Wind Speed Sensor /Transmitter)
1	Wind Vane
1	5V DC Adapter
1	U-bolt with mounting clamps
1	User manual
1	Zip bag for 1pc 10mm single-head wrench

5.2 Sensor Set Up

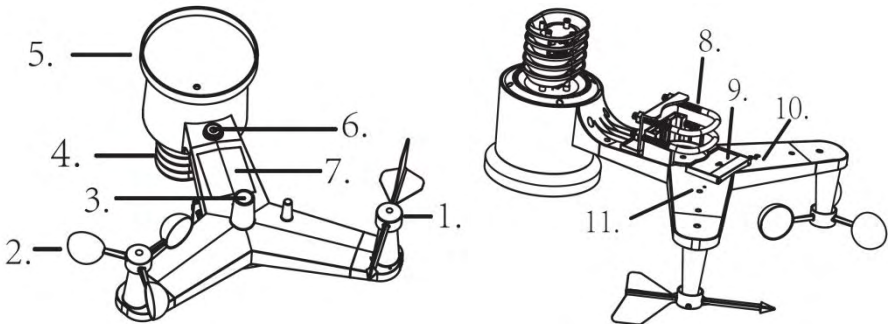

1. Wind Vane
2. Wind Speed Sensor
3. UV sensor/ Light sensor
4. Thermo-hygro sensor
5. Rain collector
6. Bubble level
7. Solar panel
8. U-Bolt
9. Battery compartment
10. Reset button
11. LED Indicator: light on for 4s if the unit power up. Then the LED will flash once every 16 seconds (the sensor transmission update period).

5.2.1 Install U-bolts and mounting pole

Installation of the U-bolts, which are in turn used to mount the sensor package on a pole, requires installation of an included metal plate to receive the U-bolt ends. The metal plate, visible in Figure 1, has four holes through which the ends of the two U-Bolts will fit. The plate itself is inserted in a groove on the bottom of the unit (opposite side of solar panel). Note that one side of the plate has a straight edge (which goes into the groove), the other side is bent at a 90-degree angle and has a curved profile (which will end up “hugging” the mounting pole). Once the metal plate is inserted, remove nuts from the U-Bolts and insert both U-bolts through the respective holes of the metal plate as shown in Figure 8.

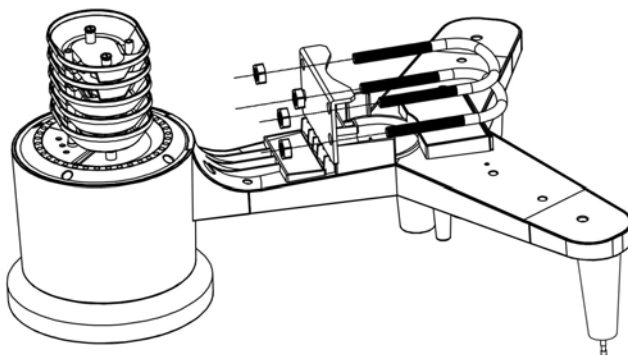

Figure 1

Loosely screw on the nuts on the ends of the U-bolts. You will tighten these later during final mounting. Final assembly is shown in Figure 9.

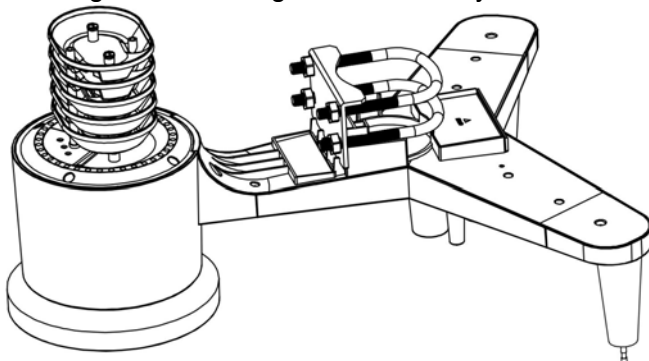

Figure 2

The plate and U-Bolts are not yet needed at this stage but doing this now may help avoid damaging wind vane and wind speed cups later on.

5.2.2 Install wind vane

Push the wind vane onto the shaft on the top of the sensor, until it stop moving further, as shown in figure 3.

Tighten the set screw, with a Philips screw driver(size PH0), until the wind van cannot be removed from the axle, as shown in figure 4. Make sure the wind vane spin freely. The wind vane’s movement has a small amount of friction, which is helpful in providing steady wind direction measurements.

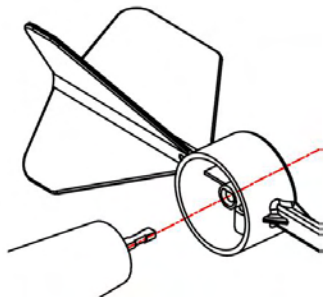

Figure 3

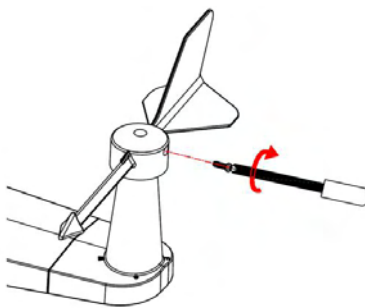

Figure 4

There are four alphabet letter of “N”, ”E”, ”S”and “W” around the wind direction, representing for the direction of North, East, South and West. Wind direction sensor has to be adjusted so that the directions on the sensor are matching with your real location. Permanent wind direction error will be installation. when the wind direction sensor is not positioned correctly during installation.

5.2.3 Install wind speed

Push the wind speed into the shaft as shown in figure 5.

Tighten the set screw with as shown in figure 5. Make sure the wind speed can spin freely.

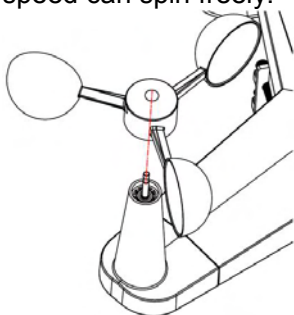

Figure 5

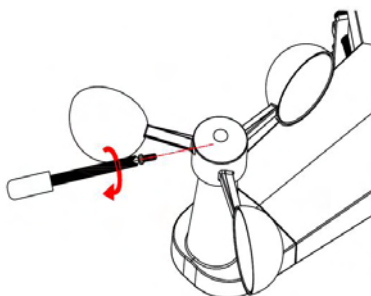
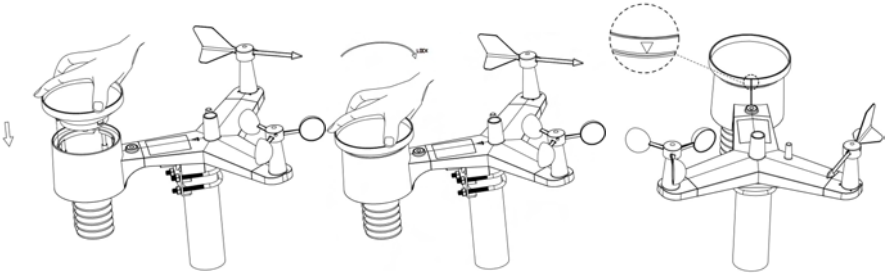

Figure 6

5.2.4 Install Rain Gauge

Keep the Indication mark in straight line. As show below photo.



5.2.5 Install Batteries

Insert 2XAA batteries in the battery compartment. The LED indicator on the back of the transmitter will turn on for four seconds and normally flash once every 16 seconds (the sensor transmission update period).

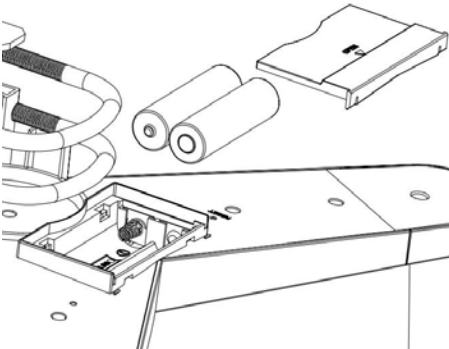

Figure 7

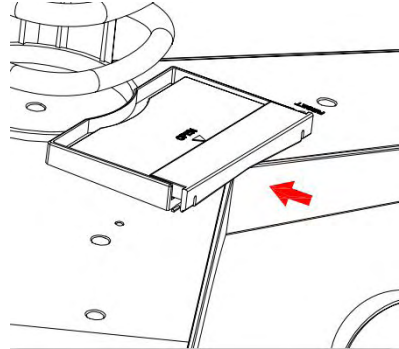

Figure 8

Note: If no LED light up or is permanently on, make sure the batteries are inserted the correct way or a proper reset has happened. Do not install the batteries backwards. You can permanently damage the outdoor sensor

Note: We recommend 1.5V lithium batteries for cold weather climates, but alkaline batteries are enough for most climates. We do not recommend rechargeable batteries. They have lower voltages, they do not operate well at wide temperature ranges, and do not last as long, resulting in poorer reception.

5.2.6 Mount assembled outdoor sensor package

5.2.6.1 Before you mount

Before proceeding with the outdoor mounting detailed in this section, you may want to skip to setup instructions in section 6.2 and onwards first, while you keep the assembled outdoor sensor package nearby (although preferably not closer than 5 ft. from the console). This will make any troubleshooting and adjustments easier and avoids any distance or interference related issues from the setup.

After setup is complete and everything is working, return here for outdoor mounting. If issues show up after outdoor mounting they are almost certainly related to distance, obstacles etc.

5.2.6.2 Mounting

You can attach a pipe to a permanent structure and then attach the sensor package to it (see Figure 9). The U-Bolts will accommodate a pipe diameter of 1-2 inches (pipe not included).

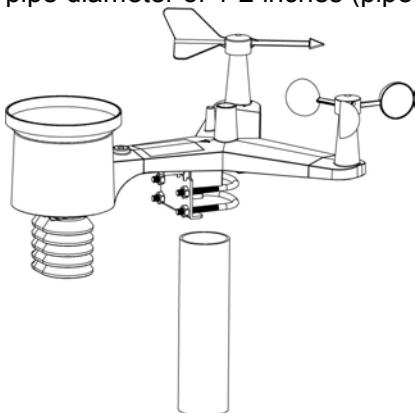

Figure 9

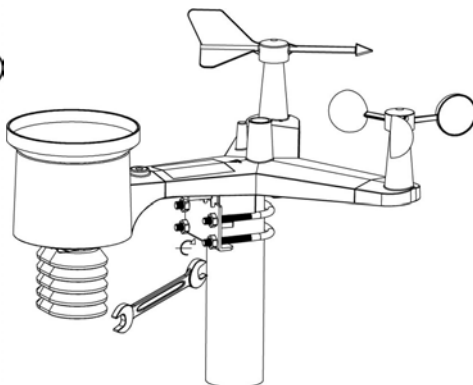

Figure 10

Finally, place the sensor package on top of the prepared mounting pipe. The U-Bolts should be loose enough to allow this but loosen the nuts as necessary. Once placed, hand tighten all four nuts, taking care to do so evenly.

Now you will need to align the whole package in the proper direction by rotating it on top of the mounting pipe as needed. Locate the arrow labeled “North” that you will find on top of the sensor package right next to the light sensor. You must rotate the whole sensor package until this arrow points due north. To achieve proper alignment, it is helpful to use

a compass (many cell phones have a compass application).

Once rotated in the correct orientation, lightly tighten the bolts a little more (use a wrench) to prevent further rotation.

Note: Use the bubble level next to the rain sensor to make sure sensor array is completely level. If the sensor is not level, the rain gauge, UV and solar radiation sensors will not measure properly.

5.2.7 Reset Button and Transmitter LED

In the event that the sensor array is not transmitting, reset the sensor array.

With an open ended paperclip, press and hold the **RESET BUTTON** for three seconds to completely discharge the voltage.

Take out the batteries and wait one minute, while covering the solar panel to drain the voltage.

Put batteries back in and resynchronize with console by powering down and up the console with the sensor array about 3 meter away.

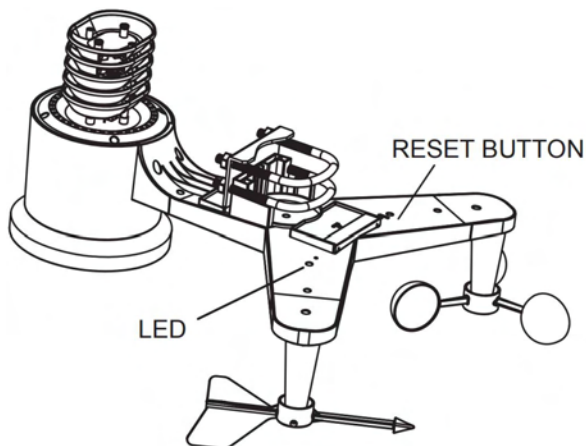

Figure 11

5.3 Best Practices for Wireless Communication



Note: To insure proper communication, mount the remote sensor(s) upright on a vertical surface, such as a wall. **Do not lay the sensor flat.**

Wireless communication is susceptible to interference, distance, walls and metal barriers. We recommend the following best practices for trouble free wireless communication.

Electro-Magnetic Interference (EMI). Keep the console several feet away from computer monitors and TVs.

Radio Frequency Interference (RFI). If you have other 433 MHz devices and communication is intermittent, try turning off these other devices for troubleshooting purposes. You may need to relocate the transmitters or receivers to avoid intermittent communication.

1. **Line of Sight Rating.** This device is rated at 300 feet line of sight (no interference, barriers or walls) but typically you will get 100 feet maximum under most real-world installations, which include passing through barriers or walls.
2. **Metal Barriers.** Radio frequency will not pass through metal barriers such as aluminum siding. If you have metal siding, align the remote and console through a window to get a clear line of sight.

The following is a table of reception loss vs. the transmission medium. Each “wall” or obstruction decreases the transmission range by the factor shown below.

Medium	RF Signal Strength Reduction
Glass (untreated)	5-15%
Plastics	10-15%
Wood	10-40%
Brick	10-40%
Concrete	40-80%
Metal	90-100%

5.4 Display console

1. Insert the 5V AC adaptor into the back of the display console
Note: Place the outdoor sensor array about 5 to 10 feet from the display console and wait several minutes for the remote sensors to synchronize with the display console.
2. Insert 3 AAA batteries into the display console. Please insert the battery as blew figure 12:

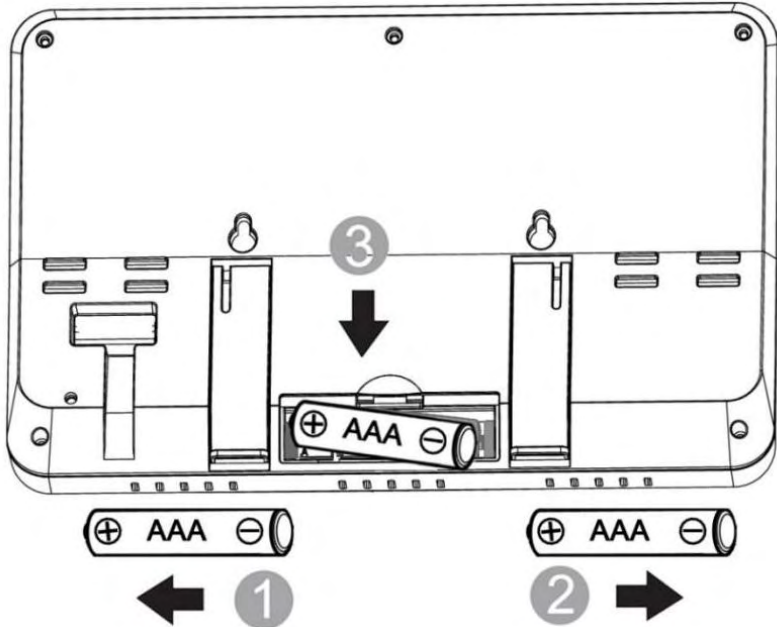

Figure 12

Note: The batteries are intended for back-up power only. The backlight will remain on for 5 seconds when on back up battery power only. Only when you use power adapter it will the back-light be continuously on.

3. Keep both sensor and the display console together for 15 minutes to lock in the sensor signals.
4. Spin the wind cups to simulate wind speed. Take the sensor to the sink and slowly drip water into the rain bucket to simulate rain.
5. After 15miuntes, follow the mounting instructions for proper placement of sensors.

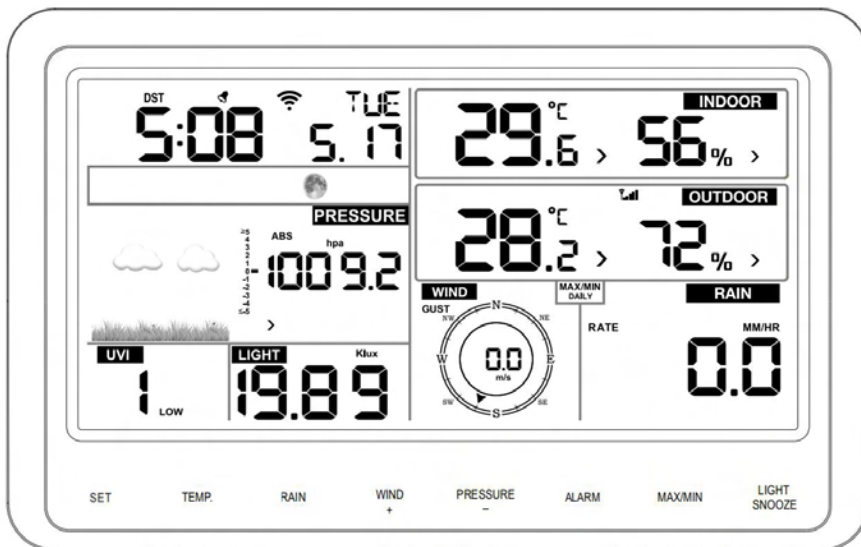

Figure 13

Note: Your display console should have readings in all sections. Wind and Rain will show 0's (connected) until wind or rain occur or are simulated.

Note: If you only use battery to power up display console, you must press LIGHT/SNOOZE key to light up the LCD before press any other key.

5.4.1 Vertical Desk Stand

The console is best viewed above from a 20 to 30 degree angle.

In addition to the fold out desk stand on the back of the display, console, the console also includes a vertical desk stand to improve the viewing able on a desk, as shown in Figure 14.

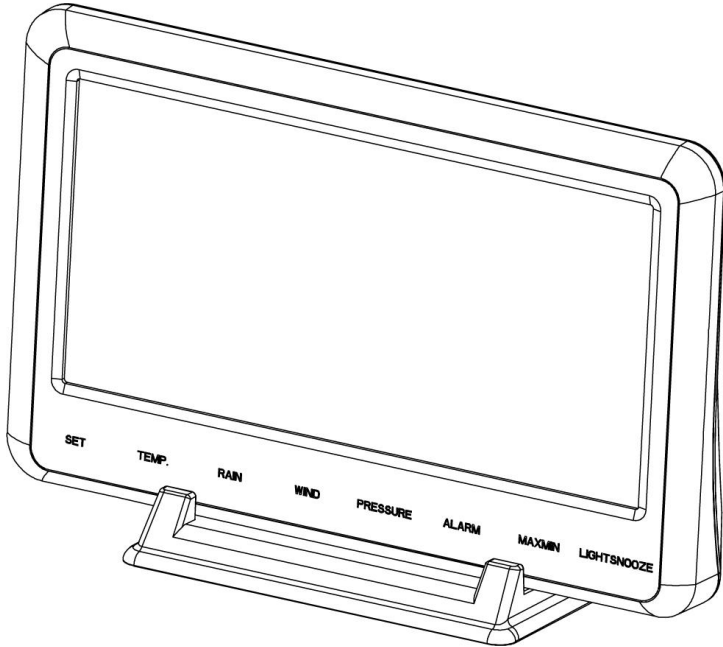
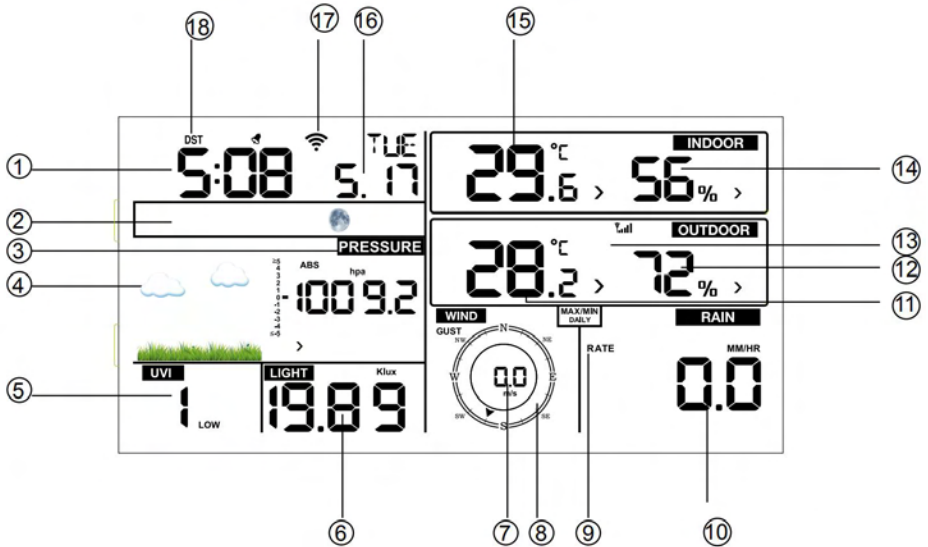

Figure 14

6. Display Console Operation

6.1 Screen Display



1. Time	10. Rain fall
2. Moon phase	11. Outdoor temperature
3. Barometric Pressure	12. Outdoor humidity
4. Weather forecast	13. RF icon
5. UV index	14. Indoor humidity
6. Light	15. Indoor temperature
7. Wind speed	16. Date
8. Wind direction	17. WIFI icon
9. MAX/MIN Daily	18. DST

6.2 Initial Display Console Set Up

Connect the power adapter to power up the display console.

The unit will show software version number 2 seconds after power reset.



The unit will turn on all segments of the LCD for 3 seconds after power reset, the unit will start to register the outdoor channel for 3 minutes.

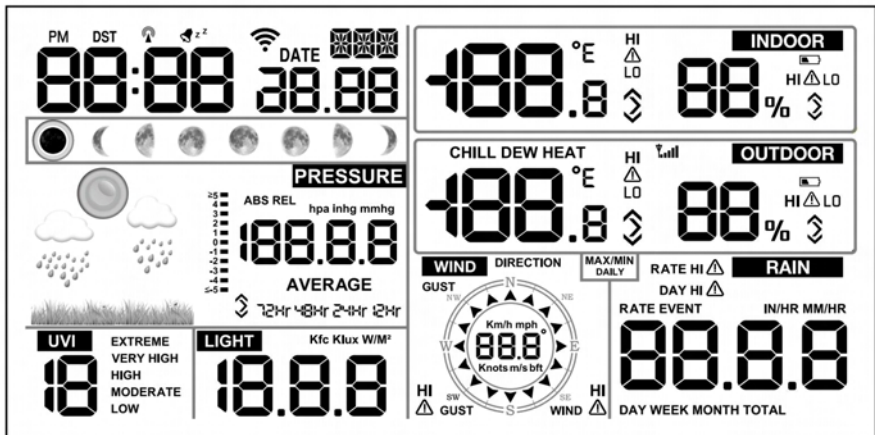

6.3 Key function

The console has eight keys for easy operation

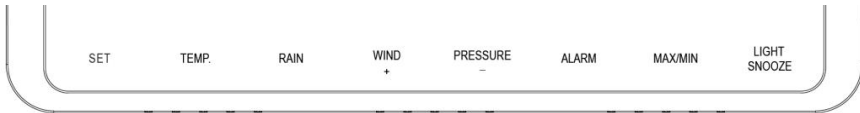

Key	Description
SET	Press this key to view MAC address. Hold this key to enter setting mode
TEMP.	Press this key to view wind Chill, Heat Index, Dew Point Temperature
RAIN	Press this key to view Rain Rate, event, Rain Day, Rain Week, Rain Month, and Rain total Press the RAIN key 2s to reset current display rain
WIND +	Press this key to view wind/gust and wind direction
PRESSURE	Press this key to view Absolute Pressure average of 12hr, 24hr, 48hr and 72hr Press and hold 2s this key to view the absolute and relative pressure
ALARM	Press this key to view the alarm value of Temperature / Humidity/rain rate/rain day/wind
MAX/MIN	Press this key to view the MAX/MIN value of Temperature / Humidity/rain rate/rain day/wind/UVI/LIGHT/Absolute Pressure
LIGHT /SNOOZE	Press this key to adjust LCD backlight brightness: HI/MID/OFF Hold this key to register new transmitter

Note:

- 1) When power on, press **WIND/+** and **PRESSURE /-** key to reset the weather station and clear all records memory, and clears all user settings to default.
- 2) When power on, press **TEMP.** key to skip receive RF signal.
- 3) In Setting mode, pressing **WIND/+** or **PRESSURE/-** key select the unit or scrolls the value; keeping press and holding **WIND/+** or **PRESSURE/-** key for 2 second will increase/decrease digits in great steps.
- 4) The setting procedure can be exited at any time by either pressing the **LIGHT /SNOOZE** key or waiting for the 30-second time-out to take effect.

6.4 Setting mode

Pressing the **SET** key for 2 seconds to enter setting model, the basic settings can now be performed in the following order:

6.4.1 BEEP:



- Press the **SET** key for 2 seconds to select the beep section, ON/OFF section digits will start flashing, press the **WIND/+** or **PRESSURE/-** key to select ON or OFF.

“BEEP ON” will make the Beep sound on every key press. If you do not want the beep sound to be heard, select “BEEP OFF”

6.4.2 MAX/MIN Daily:



- Press the **SET** key twice to select the **MAX/MIN Daily** section, ON/OFF section digits will start flashing, press the **WIND/+** or **PRESSURE/-** key to select ON or OFF . (Default is ON, ON: clear at 0:00 every day).

6.4.3 Time / Date



- Press the **SET** key third time to select the 12/24 hour format section (default: 24hr).
- Press the **SET** key fourth time to select the hour section.
- Press the **SET** key fifth time to select the minutes section.
- Press the **SET** key sixth time to select DD-MM or MM-DD format. (Default DD-MM format)
- Press the **SET** key seventh time to select year.
- Press the **SET** key eighth time to select month.
- Press the **SET** key ninth time to select day.

Note: Press the **WIND/+** or **PRESSURE/-** key to set the value.
Note: If user to change minute value, second will auto clear to 0.

Note: WIFI firmware version 1.4.4 and above support Global Time synchronization. Time zone, DST and date will automatic updated from internet when base station is connected to WIFI internet.

6.4.4 Pressure



- Press the **SET** key tenth to select the ABS pressure unit, pressure value and hPa digits will start flashing, press the **WIND/+** or **PRESSURE/-** key to select unit (hPa, inhg,mmhg)
- Press the **SET** key eleventh to select the REL pressure unit, pressure value and hPa digits will start flashing, press the **WIND/+** or **PRESSURE/-** key to select unit (hPa, inhg,mmhg)

1) Viewing Absolute vs. Relative Pressure

To switch between absolute and relative pressure, press and hold the [PRESSURE -] button for two seconds.

Absolute pressure is the measured atmospheric pressure, and is a function of altitude, and to a lesser extent, changes in weather conditions.

Absolute pressure is not corrected to sea-level conditions.

Relative pressure is corrected to sea-level conditions.

2) Rate of Change of Pressure Graph

The rate of change of pressure graphic is shown to the left of the barometric pressure and signifies the difference between the daily average pressure and the 30 day average (in hPa).



3) Viewing Pressure History

Press the [PRESSURE -] button to view the 12 hour, 24 hour, 48 hour and 72 hour pressure average.

4) Relative Pressure Calibration Discussion

To compare pressure conditions from one location to another, meteorologists correct pressure to sea-level conditions. Because the air pressure decreases as you rise in altitude, the sea-level corrected pressure (the pressure your location would be at if located at sea-level) is generally higher than your measured pressure.

Thus, your absolute pressure may read 28.62 inHg (969 mb) at an altitude of 1000 feet (305 m), but the relative pressure is 30.00 inHg (1016 mb).

The standard sea-level pressure is 29.92 inHg (1013 mb). This is the average sea-level pressure around the world. Relative pressure measurements greater than 29.92 inHg (1013 mb) are considered high pressure and relative pressure measurements less than 29.92 inHg are considered low pressure.

To determine the relative pressure for your location, locate an official reporting station near you (the internet is the best source for real time barometer conditions, such as Weather.com or Wunderground.com), and set your weather station to match the official reporting station.

6.4.5 Light



- Press the **SET** key 12th time to select light unit (lux, fc, w/m2; default: w/m2).

6.4.6 Temperature



- Press the **SET** key 13th time to select in/outdoor temperature unit, degree C digits will start flashing, press the **WIND/+** or **PRESSURE/-** key to select unit (C or F; default: C).

- In normal mode, press the **TEMP.** key to view wind Chill, Heat Index, Dew Point Temperature. Press the **TEMP.** key for 5 second, will register new transmitter.

Note: every 60 second the unit will measure indoor temperature, indoor humidity and pressure. If temperature is to lower than minimum range, will display --.-, if it is higher than highest range, will display --.-.

6.4.7 Wind speed



- Press the **SET** key 14th to select wind speed unit (km/h, mph, knots, m/s, bft; default: km/h).

- In normal mode, press and release the **WIND/+** key to view the wind, gust and wind direction.

6.4.8 Rain

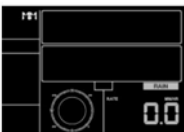

- Press the **SET** key 15th to select rainfall unit (inch or mm) the default mode is mm).

- In normal mode, press and release the RAIN key to view rain of rate, event, day, week, month and total.
- Press the **RAIN** key for 2 seconds to reset current display rain.

Note:

- Reset week rain, will auto reset day rain
- Reset month rain, will auto reset week and day rain.
- Reset total rain, will auto reset month, week and day rain.

Note:

- Rain rate: the last 10 minutes rainfall multiplication 6.
- Rain event: It start to record the rain event value form the rain falls, the rain event is over and value reset to 0 if last 24 hour rainfall less 1mm and the last 1 hour no rainfall..
- Day: defined by calendar day i.e. 0:00 - 24:00 with current date.
- Week: defined by calendar week i.e. Sunday – Saturday.
- Month: defined by calendar Month i.e. January 1 - January 31.
- Total: running total since station was powered up

Note: the transmitter will send the wind speed, wind direction, rainfall every 16 second

6.4.9 Moon phase



- Press the **SET** key 16th to select Northern or Southern Hemisphere.

6.5 Alarm mode

6.5.1 Display of Alarm value

- 1) Press and release **ALARM** key to display high alarm



- 2) Press **ALARM** key again to display low alarm







Note:

- Press **RAIN** key to select display rate or day rain alarm data.
- Press **WIND/+** key to select display wind or gust alarm data.
- Press **ALARM** key third time or press **LIGHT /SNOOZE** key back to normal mode

6.5.2 Alarm mode setting:

- 1) Press and hold for 2 seconds **ALARM** key enter alarm setting mode:
- 2) Press the **WIND/+** or **PRESSURE/-** to arm/disarm alerts and adjust alert values.
- 3) Press the **SET** key to confirm & move to the next item.
- 4) Press the **ALARM** key to on/off the alarm

Note: when alert is triggered, the current triggering source   icon

for time,   icon for high value and  icon for low value will be flashing, indicating alert is triggered.

Note: press **ALARM** key third time back to normal mode or press **LIGHT /SNOOZE** key back to normal mode.

6.5.3 Alarm Setting Order:

- 1) Time alarm setting
- 2) Indoor high temperature setting
- 3) Indoor low temperature setting
- 4) Indoor high humidity setting
- 5) Indoor low humidity setting
- 6) Outdoor high temperature setting
- 7) Outdoor low temperature setting
- 8) Outdoor high humidity setting
- 9) Outdoor low humidity setting
- 10) High wind setting
- 11) High gust setting
- 12) Rain rate high setting
- 13) Rain day high setting

6.6 Max/min mode

6.6.1 Press and release MAX/MIN key to display MAX data



- Press **TEMP.** key to view wind chill, heat index and dew point max.
- Press **RAIN** key to view rain rate, rain day, rain week and rain month max.
- Press **WIND/+** to view wind and gust max.
- Press **PRESSURE/-** to hold 2 seconds to view pressure absolute and relative max.

Press again to display min data



- Press **TEMP.** key to view wind chill and dew point min.
- Press **PRESSURE/-** to hold 2 seconds to view pressure absolute and relative min.

Note: press and hold 2s MAX/MIN button to reset all max or min.
press **MAX/MIN** key third time back to normal mode or press **LIGHT /SNOOZE** key back to normal mode.

6.7 Calibration mode

Hold the **TEMP.** and **MAX/MIN** key together for 5 seconds to enter calibration mode.



- Press the **WIND/+** and **PRESSURE/-** key to adjust values.
- Press the **SET** key to confirm & move to the next item.
- Press the **ALARM** key to reset any adjusted value.
- Press the **LIGHT /SNOOZE** key at any time to exit.

Calibration Order:

- 1) Indoor temperature offset calibrated (range +/-5°C, default: 0 degrees)
- 2) Indoor humidity offset calibrated (range +/-10%)
- 3) Outdoor temperature offset calibrated (range +/-5°C, default: 0 degrees)
- 4) Outdoor humidity offset calibrated (range +/-10%)
- 5) Absolute pressure offset calibrated (range +/-50hpa)
- 6) Wind direction offset calibrated (adjust by degree)
- 7) Wind speed factor adjust, default 100% (range 50% to 150%)
- 8) Rain factor adjust, default 100% (range 50% to 150%)

6.8 Other Features

6.8.1 Factory Reset/Clear Memory

To restore the console to factory default, perform the following steps:

1. Remove the power from the console by removing the batteries and disconnecting the AC adapter.
2. Apply power by connecting the AC adapter.
3. Wait for all of the segments to appear on the screen,.
4. Press and hold the **WIND/+** and **PRESSURE/-** keys at the same time until the console power up sequence is complete (about 5 seconds).
5. Replace the batteries.

6.8.2 Register New Transmitter

Press and hold the **LIGHT /SNOOZE** button for 5 seconds, and the console will re-register the wireless sensor.

6.8.3 Backlight Operation

1) With AC adaptor.

The backlight can only be continuously on when the AC adapter is permanently on. When the AC adapter is disconnected, the backlight can be temporarily turned on.

Press the **LIGHT SNOOZE** key to adjust the brightness between High, Low and Off.



2) Without AC adaptor

To reduce power consumption, the display console will automatically enter sleep mode and will not send data to the Internet if no key is pressed for 15s. Hold the **LIGHT /SNOOZE** key in sleep mode or plug in the DC adapter wake up equipment.

6.8.4 Tendency indicators

Tendency arrows allow you to quickly determine of temperature or pressure are rising and falling in a three hour update period, updated every 30 minutes.

Eg. : At 3:00 - compare to 12:00 data; at 3:30 -compare to 12:30 etc

Tendency indicators		Humidity	Temperature	Pressure
	Rising	Rising > 3%	Rising >= 1C/2F	Rising > 1hpa
	Steady	Change <= 3%	Change < 1C/2F	Change <= 1hpa
	Falling	Falling > 3%	Falling >= 1C/2F	Falling > 1hpa

6.8.5 Wireless Signal Strength Indicator

The wireless signal strength displays reception quality. If no signal is lost, the signal strength indicator will display 5 bars. If the signal is lost once, four bars will be displayed.

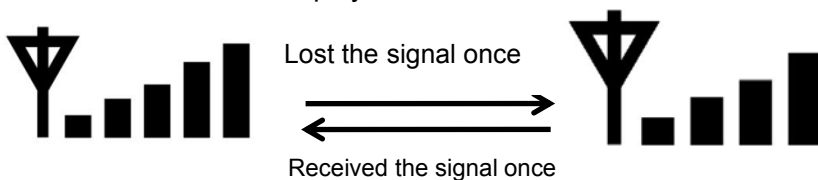

6.8.6 Weather forecast

There are six color forecast icons use changing atmospheric pressure to predict weather conditions for the next 6-hours. Please allow at least one month for the weather station to learn the barometric pressure over time.

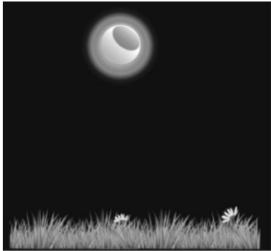

Sunny

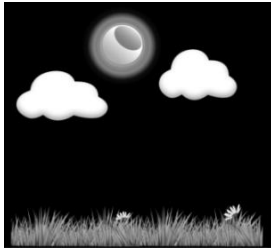

Partly sunny

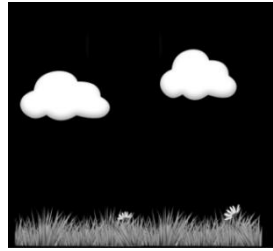

Cloudy



Rainy

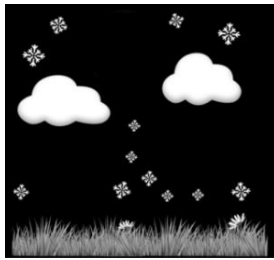

Snowy

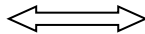
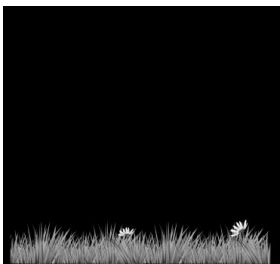

Storm rainy(Blink for 30 minutes at most)

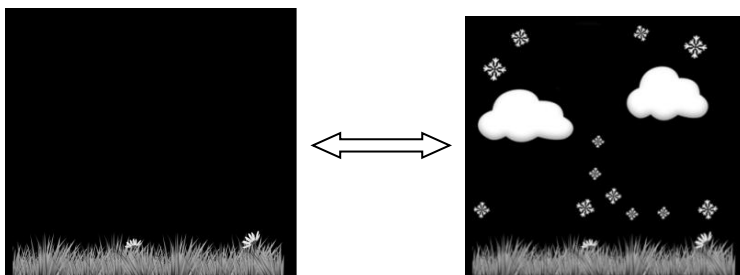

Storm Snowy(Blink for 30 minutes at most)

Note: Snowy icon will appear in place of rainy icon when the outdoor temperature is below 0°C (32 F).

Weather Forecasting Description and Limitations

In general, if the rate of change of pressure increases, the weather is generally improving (sunny to partly cloudy). If the rate of change of pressure decreases, the weather is generally degrading (cloudy, rainy or stormy). If the rate of change is relatively steady, it will read partly cloudy.

The reason the current conditions do not match the forecast icon is because the forecast is a prediction 24-48 hours in advance. In most locations, this prediction is only 70% accurate and it is a good idea to consult the National Weather Service for more accurate weather forecasts. In some locations, this prediction may be less or more accurate. However, it is still an interesting educational tool for learning why the weather changes.

The National Weather Service (and other weather services such as Accuweather and The Weather Channel) have many tools at their disposal to predict weather conditions, including weather radar, weather models, and detailed mapping of ground conditions.

6.8.7 Snooze

When the time alarm has been triggered, the alarm will sound and alarm icon will flash for 120s. Press **SNOOZE/LIGHT** key to silence the alarm for 10 minutes and then the alarm will sound again when that time is up. Press any key except SNOOZE/LIGHT key to stop the alarm.

6.8.8 MAC address display

When the external power adaptor is connected and plugged in-then press and release the SET button to view MAC address.

For example the MAC is 12:34:56:AB:CD:EF:

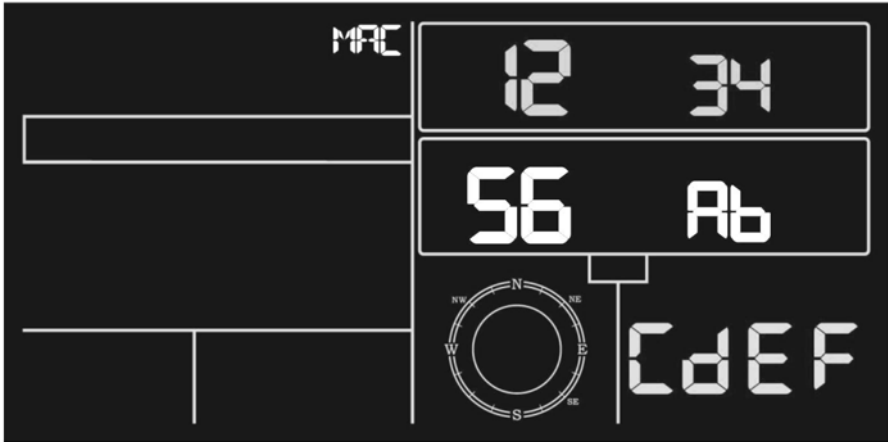

With your obtained MAC address, register your device on the Ecowitt service or customized website.

7. Specification:

Outdoor data

Transmission distance in open field	: 100m (300 feet)
Frequency	: 433MHz/868MHz (option)
Temperature range	: -40°C--60°C (-40°F to +140°F)
Accuracy	: + / - 1 °C
Resolution	: 0.1°C
Measuring range rel. humidity	: 10% ~ 99%
Accuracy	: +/- 5%
Rain volume display	: 0 – 6000mm (show --- if outside range)
Accuracy	: + / - 10%
Resolution	: 0.1mm (if rain volume < 1000mm) 1mm (if rain volume > 1000mm)
Wind speed	: 0-50m/s (0~100mph) (show --- if outside range)
Accuracy	: +/- 1m/s (wind speed < 5m/s) +/-10% (wind speed > 5m/s)
Light	: 0-200k Lux
Accuracy	: +/-15%
Measuring interval thermo-hygro sensor	: 16 s

Indoor data

Indoor temperature range	: 0°C--50°C (32°F to + 122°F) (show --- if outside range)
Resolution	: 0.1°C
Measuring range rel. Humidity	: 10% ~ 99%
Resolution	: 1%
Measuring range air pressure	: 700-1100hPa (20.67-32.5inHg)

Accuracy : +/-3hpa
Resolution : 0.1hPa (0.01inHg)
Alarm duration : 120 sec
Measuring interval indoor data : 60s

Power consumption

- Base station : 5V DC adaptor (included),
Power Consumption : 0.5 Watts (1.25 Watts during WiFi configuration mode)
- Base station : 3 x AAA batteries (not included)
- Remote sensor : 2x AA batteries (not included)
The primary power source is the solar panel. The batteries provide backup power when there is limited solar energy

8. Live Internet Publishing

Your console is capable of sending your sensor data to select internet-based weather services. The supported services are shown in the table below:

Hosting Service	Website	Description
Ecowitt Weather	https://www.ecowitt.net	Ecowitt is a new weather server that can host a bunch of sensors that other services don't support.
Weather Underground	https://www.wunderground.com	Weather Underground is a free weather hosting service that allows you to send and view your weather station data real-time, view graphs and gauges, import text data for more detailed analysis and use iPhone, iPad and Android applications available at Wunderground.com. Weather Underground is a subsidiary of The Weather Channel and IBM.
Weather Cloud	https://weathercloud.net	Weathercloud is a real-time weather social network formed by observers from around the world.
Weather Observation Website (WOW)	http://wow.metoffice.gov.uk/	WOW is a UK based weather observation website. WOW allows anyone to submit their own weather data, anywhere in the world.
Customized Website		Supports uploading to your customized website, if the website has the same protocol with Wunderground or Ecowitt

8.1 Connecting the Weather Station Console to WiFi

To send weather data to these services you must connect your console to the internet via Wi-Fi. The console can only operate using Wi-Fi when the external power adapter is connected and plugged in!

Note: If you are testing the setup with the outdoor sensor package nearby and indoor, you may want to consider connecting to Wi-Fi, but not yet configuring any of the weather services. The reason is that while indoor the temperatures and humidity recorded by the outdoor sensor, and as reported to the weather service(s) will reflect indoor conditions, and not outdoor conditions. Therefore, they will be incorrect. Furthermore, the rainfall bucket may be tripped during handling, causing rain to register while it may not actually have been raining. One way to prevent this is to follow all instructions, except to use an incorrect password, on purpose! Then, after final outdoor installation, come back and change the password after clearing console history. That will start uploading to the services with a clean slate.

8.1.1 Download mobile application

Wi-Fi configuration is done using your mobile device, either iOS or Android. Start by downloading the “WS View” application from the Apple App Store or Google Play store, as appropriate for your device.

8.1.2 Connect the console to Wi-Fi

8.1.2.1 Android user:

Now activate the application you have downloaded on your mobile device. The following instructions will generally show screen shots for the Android application side by side.

Configure Device



1)

Select the device you have from the device list, then press **Next**



2)

Operate as per the information, tick the box to confirm “completed operation”, press **Next**.

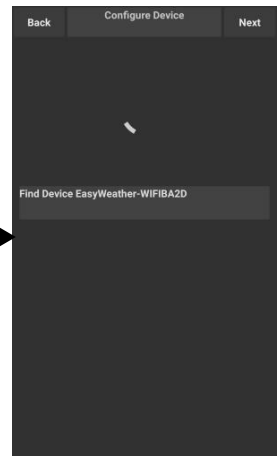

3)

Start searching the device. If the device is in your WLAN list., it will jump to the 4) screen shot.

The device named “EasyWeather-WIFI” followed by four characters.

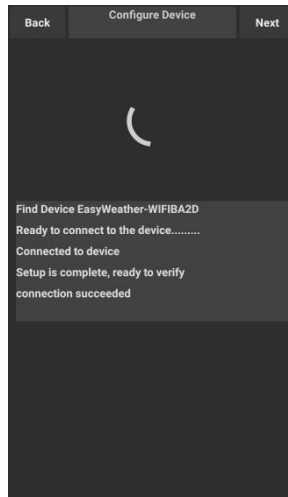
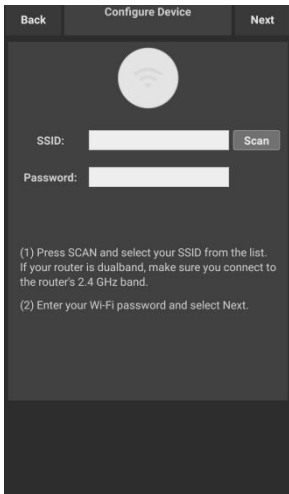

4)

Press Scan and select you **SSID** from the list, then enter your WiFi **password** and press **Next**.

If you own a dual band router (2.4 GHz and 5.0 GHz), make sure you connect to the 2.4 GHz band, otherwise it will fail to connect the weather station to WiFi.

5)

Start to connect your phone to the weather station "EasyWeather-WIFI" to your router. Configure successfully it will jump to "**Upload Setting**" screen automatically. .

Upload Setting

Your console is capable of sending your sensor data to select internet-based weather services: ecowitt.net, Wunderground.com, weathercloud.net, wow.metoffice.gov.uk and Customized Website. User need to register at the select website to get the station ID(or MAC address) and password

a. Upload your weather data to ecowitt Website

It's recommended to use the Ecowitt Weather server to monitor and record your sensors data. Supports uploading all the sensors data to Ecowitt Weather server. For other weather services, Only server-supported data will be uploaded.



1)

On the **ecowitt.net** uploading page, enable the ON button (displayed blue) and set the uploading interval time. Press **Save** on the page.

Copy the MAC address (will be used to add the device on the server later)

Press Register at Ecowitt.net to open web browser to activating the Register with Ecowitt.net option

After add device and upload data successfully, if you found the data not reporting to server, presss Response Time to reset and check the reponse status.

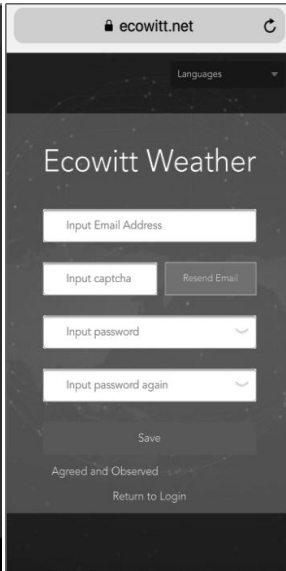

2)

Finish the registration on the Ecowitt page

If you have account and password, press **Return to Login** to login the website

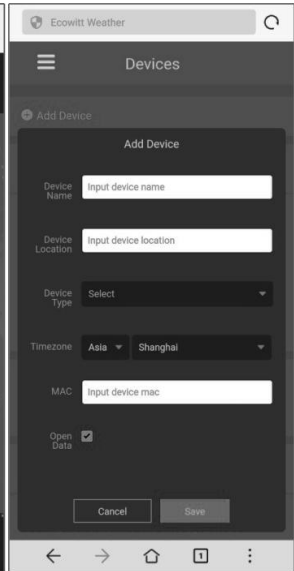

3)

Press the upper left menu button and select Devices. Press Add Device and input all the information needed. Press **Save**.

If you tick **Open data**, your weather data can be viewed by other people.

Note: When select device address on map, please wait till the map display before selecting your address.

Note: Please put in the correct time zone to get the correct time. Because the time will be updated to internet time automatically while WIFI connection.

Once registered, select the dashboard to view your data, as shown below:

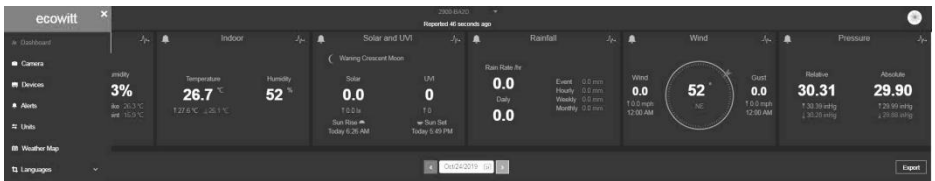

Ecowitt.net is a responsive design and mobile friendly. Simply open your mobile devices web browser, browse to ecowitt.net, and bookmark your dashboard for quick access.

b. Upload your weather data to Wunderground.com

Back Upload EasyWeather-WIFBAZD Next

Wunderground

Station ID:
[Input Field]

Station Key:
[Input Field]

Register at Wunderground.com

Save

EasyWeather v1.3.8.2

If you don't have Wunderground Station ID, you can select 'Register at Wunderground.com' to register your weather station. Enter the Station ID and Station Key and select Save.



station.

- You can delete your account at any time from your member settings.

The Weather Company needs your email to create your Weather Underground account.

Email
[Input Field]

Password (5-30 characters) Show
[Input Field]

Confirm New Password:
[Input Field]

I agree to the Terms of Use

Sign up for free

Already have an account? Sign in

Terms of Use | Privacy Policy



PWS Management | Weather Underground

Name:(Required)
Give Your Device a Name

Elevation:(Required)
1512.46724

Device Hardware:(Required)
Select device hardware

Height Above Ground:
Ft. Above Ground

Surface Type:
Select device surface

Associate Webcam:

Navigation icons: back, forward, home, square, dots

1)

On the **Wunderground.com** uploading page, input Station ID & Station Key, press **Save**. Your station ID will be added on the WU StationID.

then press **Next**. Jump to the screen about Upload your weather data to Weathercloud.net

If you don't have Wunderground Station ID and Key, press "**Register at Wunderground.com**" to activating the Register with Wunderground option

2)

Register at Wunderground.com

Enter your valid **e-mail address** and **password** to register and create your weather underground account. You will be presented with a form to fill out

3)

Complete and submit the form.

If you can't find your weather station model number from the drop-down menu, please select "others".

Congratulations! Your personal weather station is now registered with Weather Underground.

Enter the information below to your weather station software.

Your PWS

Station ID:

WU01111111

Station Key:

1234567890



Configure Your Software

4)

Once register successfully, you'll receive a new Station ID and password / key and an e-mail about the information of Station ID and Station password / key

Back to the **Wunderground.com** uploading page, input Station ID & Station Key, press **Save**. Your station ID will be added on the WU StationID.

c. Upload your weather data to Weathercloud.net

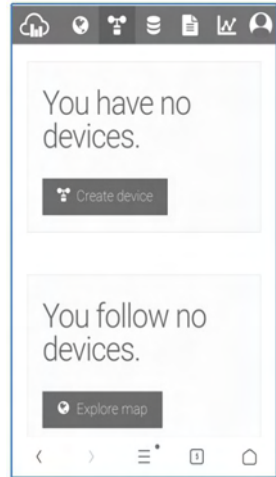
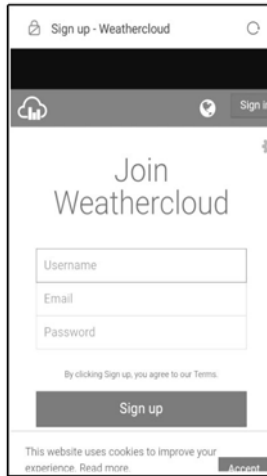
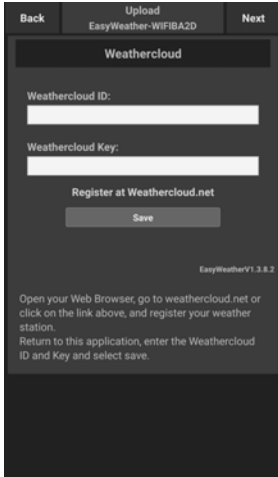

1)

Upload your weather data to **Weathercloud.net**

Input Weathercloud ID & Weathercloud Key, press **Save..**

Then press **Next**. Jump to the screen about Upload your weather data to Weather Observation Website (WOW)

If you don't have Weathercloud ID and Key, press "Register at Weathercloud.net" to open your web browser to activating the Register with Weathercloud.net option

2)

Register at Weathercloud.net

Visit weathercloud.net and enter a Username, Email and Password to sign up

Respond to the validation email from Weathercloud (it may take a few minutes)

3)

You will then be prompted to add a device/ Select "Create device" and enter your station's information:

After registering your station, take note of the "Weathercloud ID" and "Key" presented to you.

Enter these values in the mobile application.

d. Upload your weather data to WeatherObservationWebsite (WOW)

1)

Upload your weather data to WOW

Input Weathercloud ID & Weathercloud Key, press **Save**..

then press **Finish**. Jump to the **Device List** home screen

If you don't have WOW ID and Key, press " Register at WeatherObservationWebsite" to open your web browser to activating the Register with WOW option

2)

Register at WeatherObservationWebsite

Choose create a new account you will be presented with a form to fill out

3)

The actual form is longer, but all questions should be self-explanatory.

Complete and submit the form. You will shortly receive an email with instructions on how to login

Now wait for the email to arrive and click the link in that email to confirm your email address.

Follow instructions on the screen and login to the site

Once you are logged in you will need to create a new WOW site. “Sites” are the means by which WOW organizes weather data you contribute. Basically, WOW builds a personal web site for your weather station. Associated with the web site is two items you will need to allow uploading of data:

Site ID: This is an arbitrary number that is used to distinguish your site from another. This number appears (in brackets) next to or underneath the name of your site on the site information page, for example: 6a571450-df53-e611-9401-0003ff5987fd

Authentication Key: This is a 6-digit number that is used to ensure data is coming from you and not another user.

Begin setting up a new site by clicking “Enter a Site”:

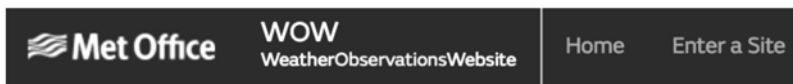

You will be presented with a form where you detail your station’s location and a bunch of other settings related to how you wish the site to operate. After you complete the setup, you should see:

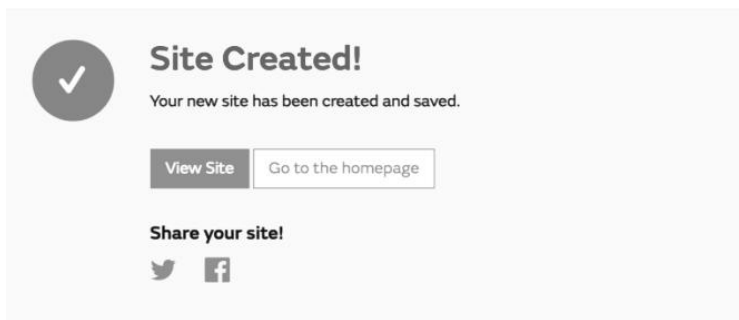

Make sure you are (still) logged in to the WOW site. Login as necessary. Now click on “My Sites” in the navigation bar at the top. If you have only 1 site, you will now be shown its page. If you have multiple, you will have to choose the correct one first. On this page, you will find the site id just below the map:



You will also need to establish a unique 6 digits PIN code that you should keep secret. It is the “Authentication Key.” Setup this number by clicking on “Edit Site”) and filling out the with a 6-digit number of your choice:

Authentication Key

You will need both “Site ID” and “Authentication Key” to setup the upload configuration for WOW in the Weather Server.

In your mobile application, navigate to the “Device List” page and tap on the device you want to configure WOW for. You will then be shown the “wunderground.com” configuration. Please ignore and tap “Next” to see the “Weathercloud” configuration. Please press “Next” one more time and you will now be on the screen where you will configure WOW.

On this screen you will fill out “Station ID” with the WOW “Site ID” value, and “Station Key” with the WOW “Authentication Key” you created. Press “Save” to finalize the configuration.

e. Upload your weather data to Customized Websit

Customized

Disable Enable

Protocol Type Same As:

Ecowitt Wunderground

Server IP / Hostname :

Station ID:

Station Key:

Port:

Upload Interval: Seconds

Save

EasyWeatherV1.3.8.2

If you want to upload data to your customized website, select **Enable** button (display blue) and select the protocol type. The website should have the same protocol with Wunderground or Ecowitt. Input all the information needed. Press **Save**.

8.1.2.2 iOs user:

Activate the application you have downloaded on your mobile device. The main screen will indicate your station is off-line (because it is not yet connected to Wi-Fi).

Current Conditions		Station ID
No Station ID		
--		
Temperature		--
Dew Point		--
Relative Humidity		--
Relative Pressure		--
Wind Direction		--
Wind Speed		--
Wind Gust Speed		--
Solar Radiation		--
Rainfall Rate		--
Rainfall Today		--

Configure Device

Note: If you own a dual band router (2.4 GHz and 5.0 GHz), make sure you connect to the 2.4 GHz band, otherwise it will fail to connect the weather station to WiFi.

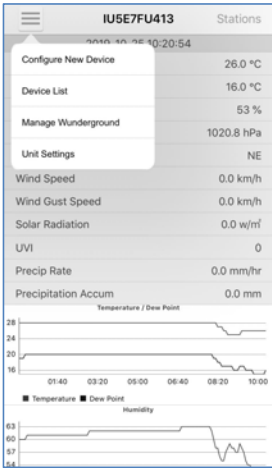

1)

Tap on the settings icon and select “Configure a New Device”.



2)

Select the device you have from the device list, then press Next



3)

Operate as per the information, tick the box to confirm “completed operation”, press **Next**.

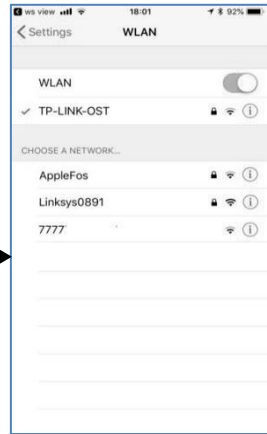
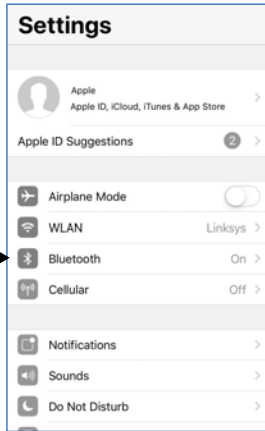
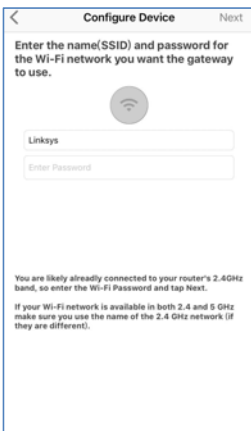

4)

Press **Sycn** and select your WiFi network from the WLAN list, then enter your WiFi password and press **Next**.

select your WiFi network you want and return to WS View App



5)

Press button “Select WiFi” to go to Wi-Fi Setting

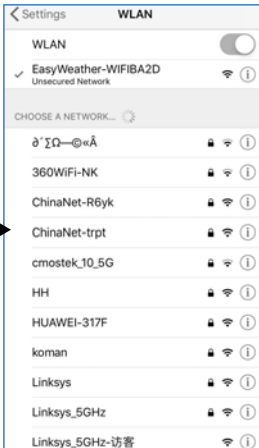

6)

Select device WiFi. The device named “EasyWeather-WiFixxxxl” and return to WS View App



7)

Connection success, it will jump to “**Upload Setting**” screen automatically.

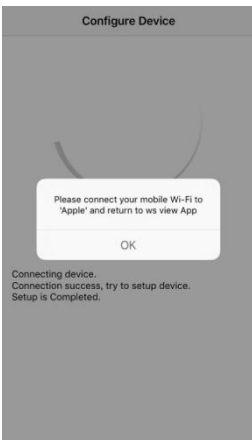

8)

It may have chance to happen that it cannot return back the same WiFi network which you selected on step 4) The window “Please connect your mobile Wi-Fi to xxxx(WiFi Network name) and return to WS View App” will pop up. Press **OK** to continue.

Upload Setting

Your console is capable of sending your sensor data to select internet-based weather services: Wunderground.com, Weathercloud.net and, wow.metoffice.gov.uk. User need to register at the select website to get the station ID and password

a. Upload your weather data to Ecowitt Website

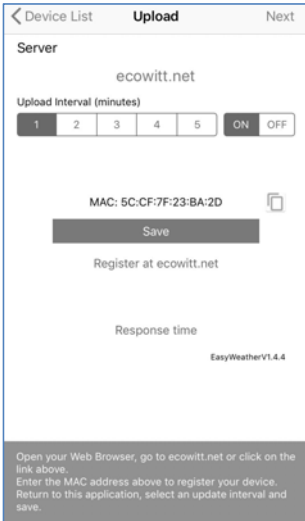

1)

On the **ecowitt.net** uploading page, enable the ON button (displayed blue) and set the uploading interval time. Press **Save** on the page.

Copy the MAC address (will be used to add the device on the server later)

Press Register at Ecowitt.net to open web browser to activating the Register with Ecowitt.net option

After add device and upload data successfully, if you found the data not reporting to server, press Response Time to reset and check the response status.

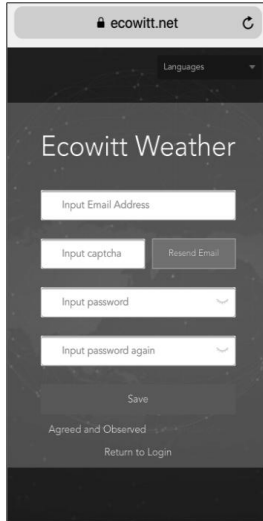

2)

Finish the registration on the Ecowitt page

If you have account and password, press **Return to Login** to login the website

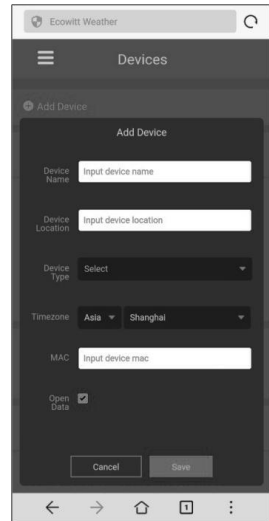

3)

Press the upper left menu button and select Devices. Press Add Device and input all the information needed. Press **Save**.

If you tick **Open data**, your weather data can be viewed by other people.

b. Upload your weather data to Wunderground.com

1)

Upload your weather data to **Wunderground.com**

Input Station ID & Station Key, press **Save**. Your station ID will be added on the WU StationID.

then press **Next**. Jump to the screen about Upload your weather data to **Weathercloud.net**

If you don't have Wunderground Station ID and Key, press "**Register at Wunderground.com**" to activating the Register with Wunderground option

2)

Register at Wunderground.com

Enter your valid **e-mail address** and **password** to register and create your weather underground account. You will be presented with a form to fill out

3)

Complete and submit the form.

If you can't find your weather station model number from the drop-down menu, please select "others"



4)

Once register successfully, you'll receive a new Station ID and password / key and an e-mail about the information of Station ID and Station password / key.

Back to the **Wunderground.com** uploading page, input Station ID & Station Key, press **Save**. Your station ID will be added on the WU StationID.

c. Upload your weather data to Weathercloud.net

Input Weathercloud ID & Weathercloud Key, press **Save**. Then press **Next**. Jump to the screen about Upload your weather data to WeatherObservation Website (WOW)

If you don't have Weathercloud ID and Key, press "Register at Weathercloud.net" to open your web browser to activating the Register with Weathercloud.net option. Please refer 8.1.2.1 **Register at Weathercloud.net**. The operation is same

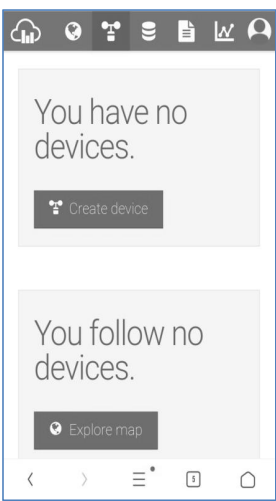
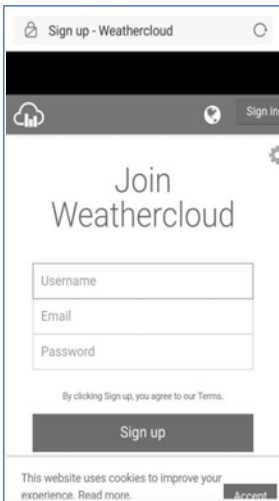
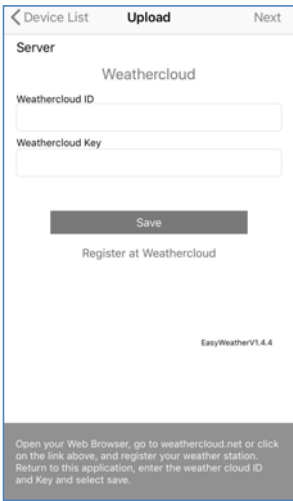

d. Upload your weather data to WeatherObservationWebsite (WOW)

Input Weathercloud ID & Weathercloud Key, press **Save**. Then press **Finish**. Jump to the **Device List** home screen

If you don't have WOW ID and Key, press " Register at WeatherObservationWebsite" to open your web browser to activating the Register with WOW option.

Please refer 8.1.2.1 **Register at WeatherObservationWebsite**. The operation is same

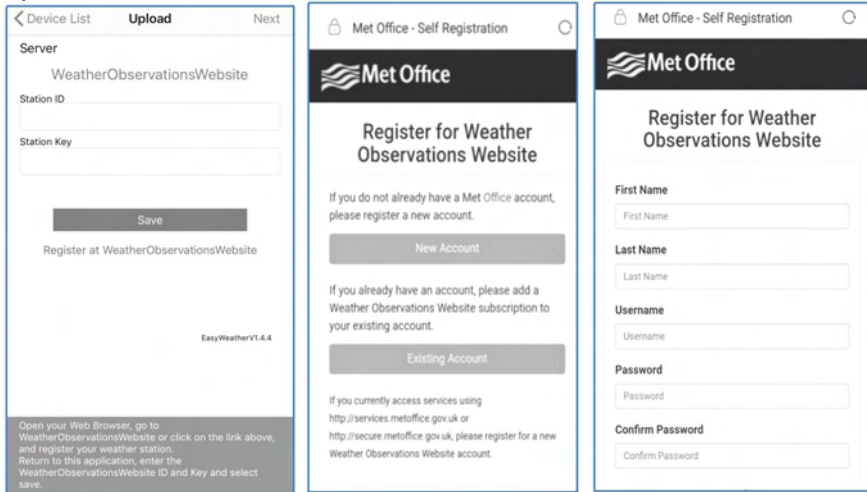

e. Upload your weather data to Customized Websit



If you want to upload data to your customized website, select **Enable** button (display blue) and select the protocol type. The website should has the same protocol with Wunderground or Ecowitt. Input all the information needed. Press **Save**.

8.2 Mobile application – Device list

You are able to see your console through the “Device List” menu option:

Tapping on your console’s entry in the device list will bring you to the page where you can change WU registration information. If you want to stop your console upload data to Wunderground, delete your Station ID and select “**Save**”.

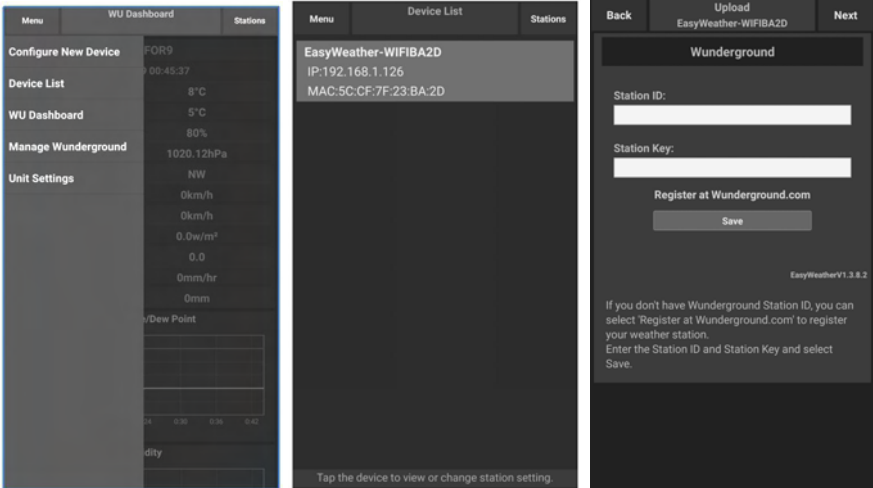

Mobile application – Device List (Android)

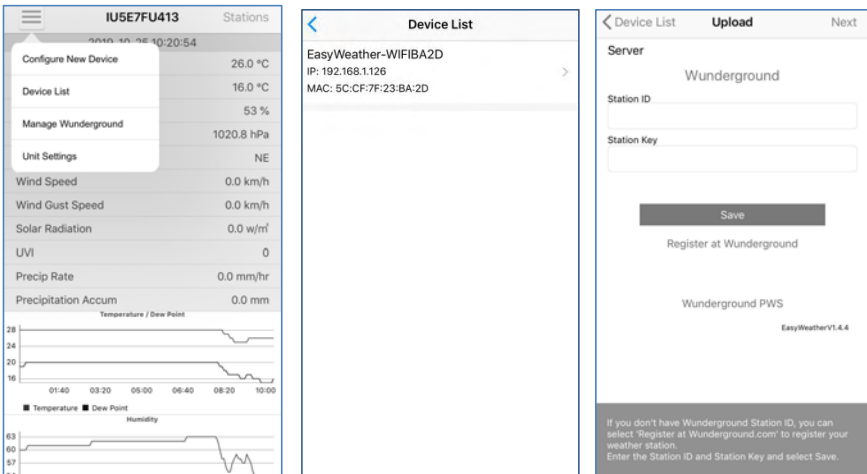

Mobile application – Device List (iOS)

8.3 Mobile application – Check WU weather data and graph

In the mobile application tap **Menu** choose **WU Dashboard** and you will be presented with a page listing current conditions for that station.

If you have added multiple WU IDs, tap on the WU Station ID to switch to view data from other IDs.

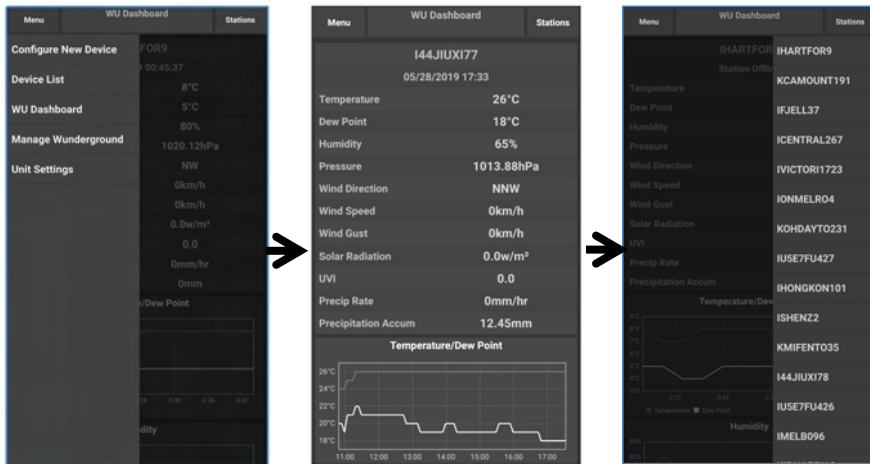

Mobile application – WU Daseboard (Android)

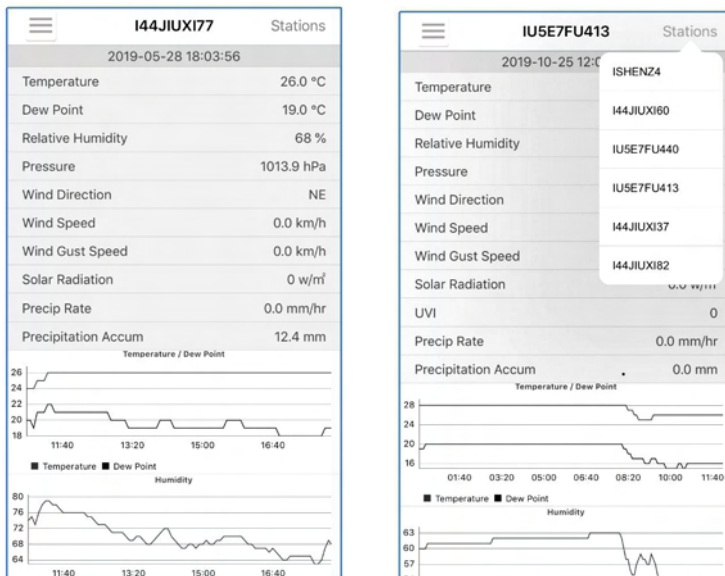

Mobile application – WU Daseboard (iOS)

8.4 Mobile application – Remove or Add WU ID

If you have previously registered your console for use with wunderground.com and wish to remove this device data display from App, use the “**Manage WU Station**” menu option after tapping on the settings icon, select “**Delete**” your console from the list and confirm you wish to delete the station. The Station ID will delete from WU Station ID list and will not have the data information on the APP. But the data will upload to Wunderground.com as usual.

If you want to add a new weather station to view its data on APP, and this device have registered in Wunderground.com, select “**Add WU Station ID**” and input the WU station ID of this new device.

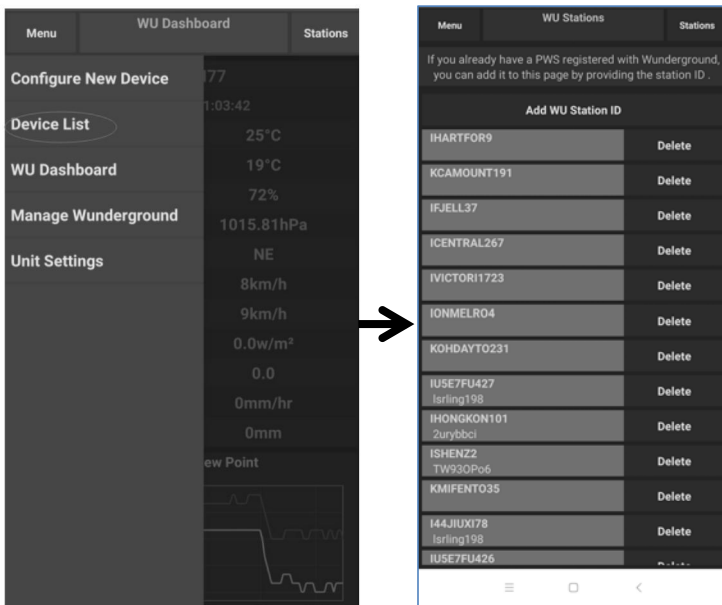

Mobile application –Remove or Add WU ID (Android)

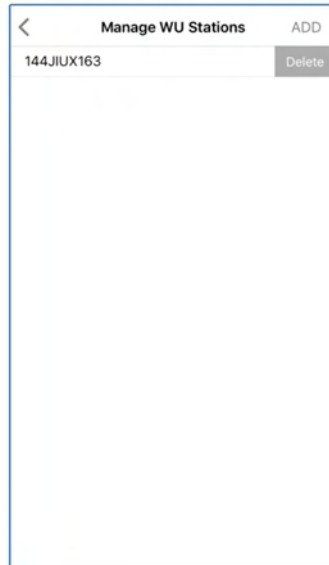
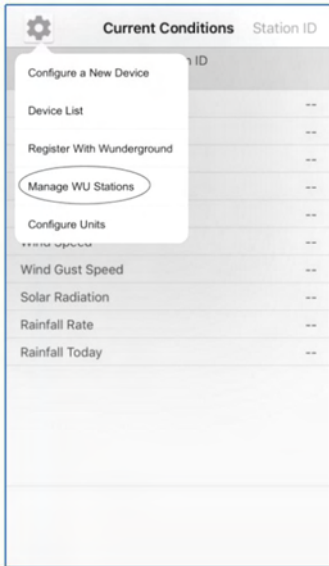

Mobile application –Remove or Add WU ID (iOS)

8.5 Mobile application – Set Units

You may want to change the units in which sensor values are reported. To do so, click on the **“Configure Units”** menu after tapping on the settings icon. Next, tap on the sensor type you wish to change the reporting units for and set the units as desired.

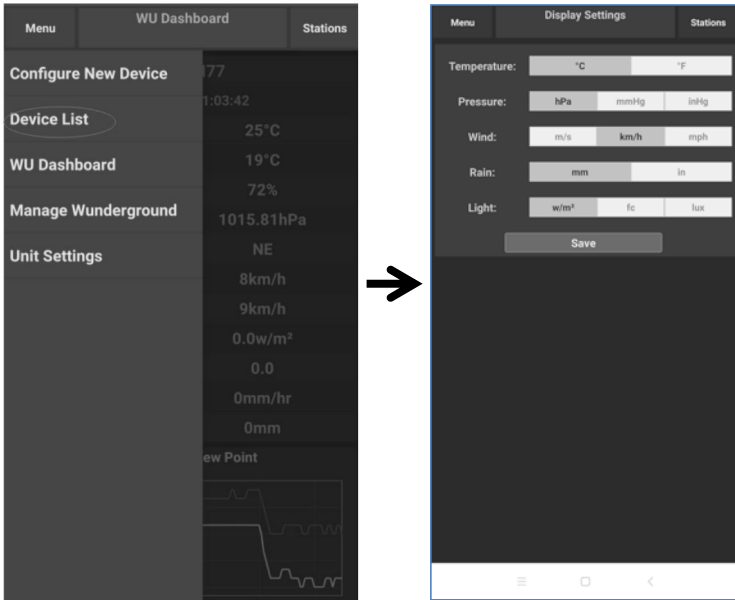

Mobile application – Change units (Android)

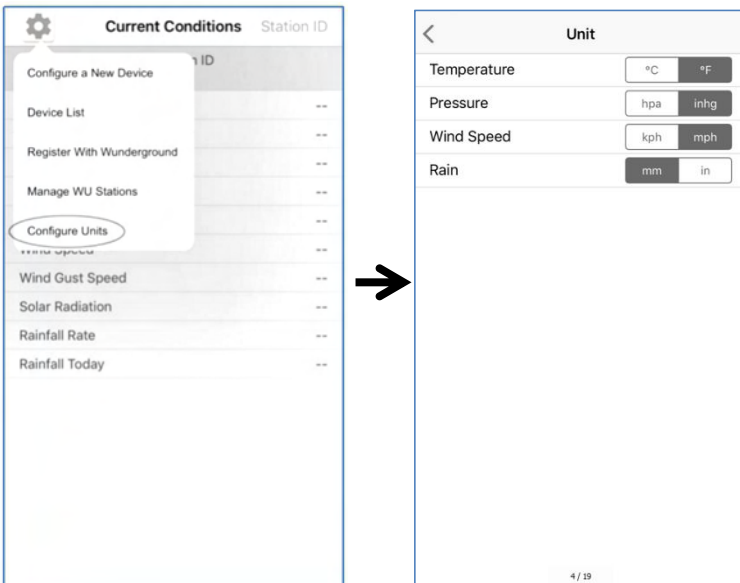

Mobile application – Change units (iOs)

9. Registering WeatherUnderground.com through the PC or Mac

If you have not already done setup for wunderground.com during the Wi-Fi setup, you can do so later. Perform the following steps:

1. Visit Wunderground.com and click **Join** as the right top arrow indicates and select the **Sign up for free** option.

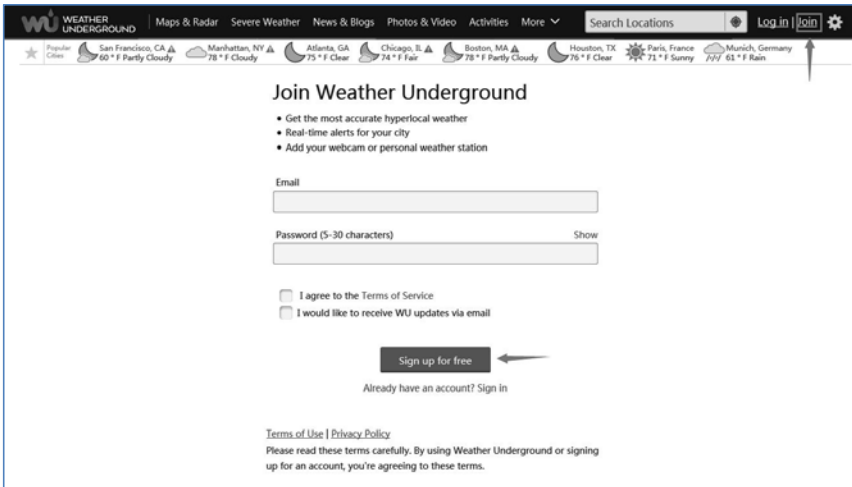

The screenshot shows the Weather Underground website's registration page. At the top, there is a navigation bar with the 'wU WEATHER UNDERGROUND' logo, menu items like 'Maps & Radar', 'Severe Weather', 'News & Blogs', 'Photos & Video', 'Activities', and 'More', a search bar, and 'Log in' and 'Join' buttons. Below the navigation bar, there are weather cards for various cities: San Francisco, CA (60°F Partly Cloudy), Manhattan, NY (78°F Cloudy), Atlanta, GA (75°F Clear), Chicago, IL (74°F Fair), Boston, MA (78°F Partly Cloudy), Houston, TX (76°F Clear), Paris, France (74°F Sunny), and Munich, Germany (77°F Rain). The main heading is 'Join Weather Underground'. Below this, there are three bullet points: 'Get the most accurate hyperlocal weather', 'Real-time alerts for your city', and 'Add your webcam or personal weather station'. There are two input fields: 'Email' and 'Password (5-30 characters)'. Below the password field is a 'Show' link. There are two checkboxes: 'I agree to the Terms of Service' and 'I would like to receive WU updates via email'. A 'Sign up for free' button is highlighted with a white arrow pointing to it. Below the button is the text 'Already have an account? Sign in'. At the bottom, there are links for 'Terms of Use' and 'Privacy Policy', and a paragraph: 'Please read these terms carefully. By using Weather Underground or signing up for an account, you're agreeing to these terms.'

2. Click **More** and select **Add Weather Station** to register your station

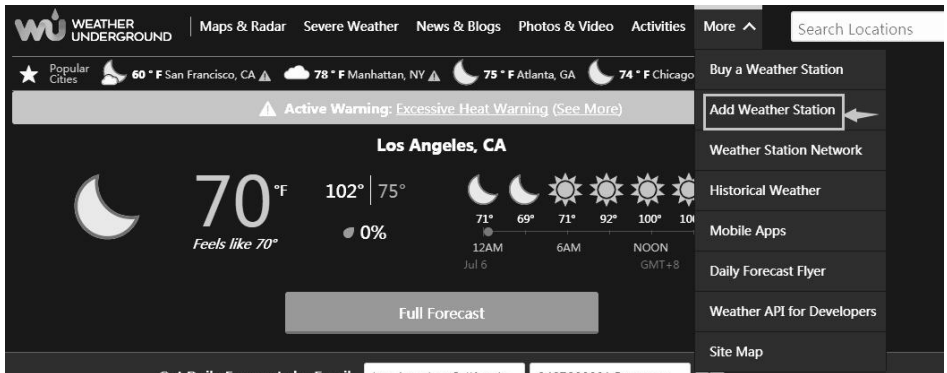

The screenshot shows the Weather Underground mobile app interface. At the top, there is a navigation bar with the 'wU WEATHER UNDERGROUND' logo, menu items like 'Maps & Radar', 'Severe Weather', 'News & Blogs', 'Photos & Video', 'Activities', and 'More', and a search bar. Below the navigation bar, there are weather cards for various cities: San Francisco, CA (60°F Partly Cloudy), Manhattan, NY (78°F Cloudy), Atlanta, GA (75°F Clear), and Chicago, IL (74°F Fair). Below the weather cards, there is a warning banner: 'Active Warning: Excessive Heat Warning (See More)'. The main heading is 'Los Angeles, CA'. Below this, there is a large weather card showing '70°F' and 'Feels like 70°'. There are also icons for '102° | 75°' and '0%'. Below the weather card, there are icons for '71° 69° 71° 92° 100° 101°' and '12AM 6AM NOON GMT+8'. Below the weather card, there is a 'Full Forecast' button. At the bottom, there are links for 'Get Daily Forecasts by Email', 'Los Angeles, CA forecasts', and '3487803331@wunderground.com'. On the right side, there is a 'More' menu with options: 'Buy a Weather Station', 'Add Weather Station' (highlighted with a white arrow), 'Weather Station Network', 'Historical Weather', 'Mobile Apps', 'Daily Forecast Flyer', 'Weather API for Developers', and 'Site Map'.

Personal Weather Station Network

Overview [Buying Guide](#) [Register with WU](#)

Step 1: Register Your Station

1. Type in the **city, state, country** where your weather station will be located.
2. Drag the **red marker** to your specific location.

1032 West 8th Street, Los Angel...

Latitude: 34.0494
Longitude: -118.264099

Elevation (ft):

Height Above Ground (ft):

[Verify Location →](#)

3. Clicks verify **location** and fill out the form.
After submitting the form, you will see the following:

Step 3: Add Your WU Info to Your Weather Station Software

Congratulations. Your station is now registered with Wunderground!
You are almost done. Now go to your weather station software and add the following:

Your Station ID:
KCALOSAN764

Your Station Key/Password:
v8cp612c

[My Weather Stations](#)

It may take a few minutes or several hours for your station to start sending data to Weather Underground.
ID and Password are case-sensitive. Process may require you to register with a 3rd party site (eg. *rainwise.net*).

Not seeing your station data yet? Check out our PWS Help Center.

Note: Your station ID will have the form: KSSCCCC###, where K is for USA station (I for international), SS is your state, CCCC is your city and ### is the station number in that city.

In the example above, KAZPHOEN424 is in the USA (K), State of Arizona (AZ), City of Phoenix (PHOEN) and #424.

Viewing your Data on Wunderground.com

You can also observe your weather station’s data by using the wunderground.com web site. You will use a URL like this one, where your station ID replaces the text “STATIONID”:

<http://www.wunderground.com/personal-weather-station/dashboard?ID=STATIONID>

It will show a page such as this, where you can look at today’s data and historical data as well:

(Darwin (+9:30 Zone) Test Station **IDARWIN13** About this PWS Report Comments
 Forecast for Darwin, AU > -12.460 130.841 > 66 ft
 PWS Data PWS Widgets WunderStation My PWS
 PWS viewed 3 times since July 1, 2018

Current Conditions Station reported 0 second ago
78.4 °F
 Feels Like 78.4 °F
12.1 mph Wind from ENE
 Gusts 12.5 mph

Dew Point: 66.2 °F
 Humidity: 66%
 Precip Rate: 0.00 in/hr
 Precip Accum: 0.00 in
 Pressure: 29.80 in

UV: 0.0
 Solar: 0 w/m²
 Soil Moisture: --
 Soil Temp: --
 Leaf Wetness: --

7:08 AM 6:33 PM
 Waning Gibbous | 50% Illuminated

Weather History for Darwin, [IDARWIN13]
 Previous Daily Month Jul 6 2018 View Next

Summary July 6, 2018

	High	Low	Average		High	Low	Average
Temperature	82.4 °F	77.4 °F	79.9 °F	Wind Speed	13 mph	--	12 mph
Dew Point	73.8 °F	64.6 °F	70.1 °F	Wind Gust	14 mph	--	--
Humidity	79%	63%	70%	Wind Direction	--	--	West
Precipitation	0 in	--	--	Pressure	29.67 in	29.59 in	--

There are also some very useful mobile apps. The URLs provided here go to the Web version of the application pages. You can also find them directly from the iOS or Google Play stores:

- WunderStation:** iPad application for viewing your station's data and graphs
<https://itunes.apple.com/us/app/wunderstation-weather-from-your-neighborhood/id906099986>

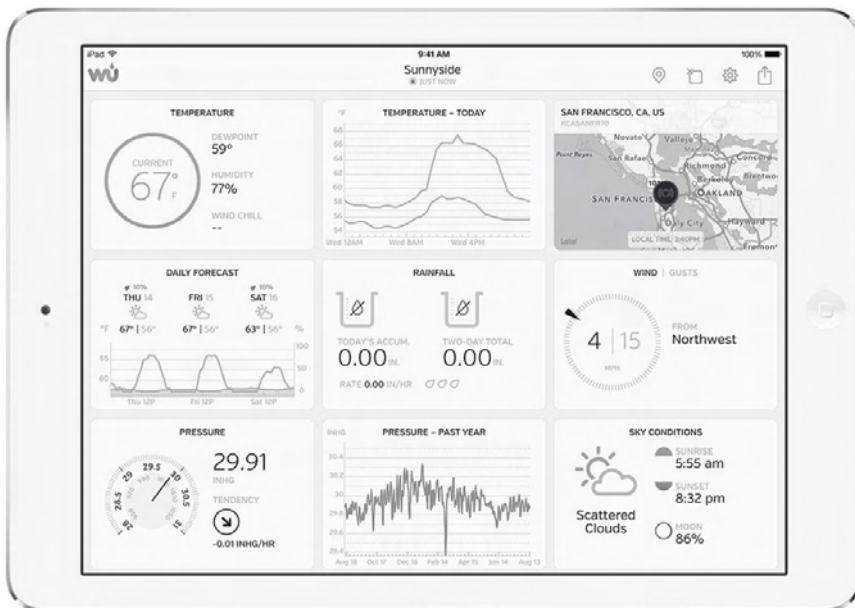

- WU Storm:** iPad and iPhone application for viewing radar images, animated wind, cloud coverage and detailed forecast, and PWS station data
<https://itunes.apple.com/us/app/wu-storm/id955957721>

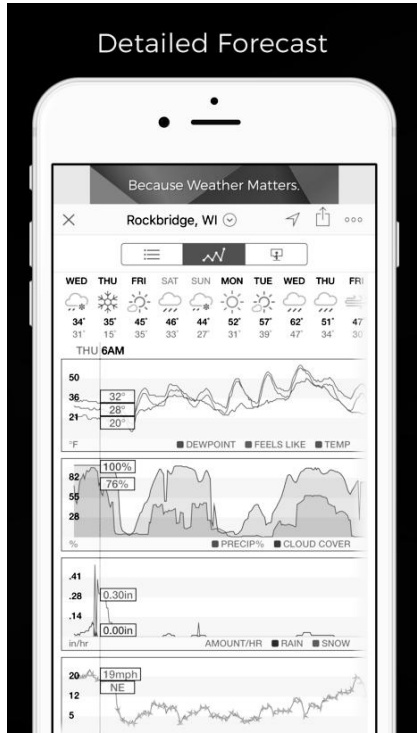

- Weather Underground: Forecast: iOS and Android application for forecasts

<https://itunes.apple.com/us/app/weather-underground-forecast/id486154808>

<https://play.google.com/store/apps/details?id=com.wunderground.android.weather&hl=en>

Current conditions at a glance



Geek out on data

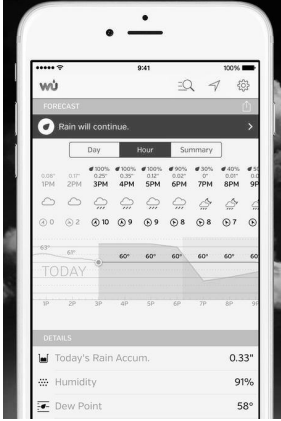

Interactive radar and satellite

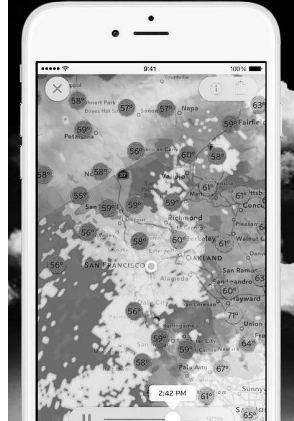

- PWS Weather Station Monitor: View weather conditions in your neighborhood, or even right in your own backyard. Connects to wunderground.com

<https://itunes.apple.com/us/app/pws-weather-station-monitor/id713705929>

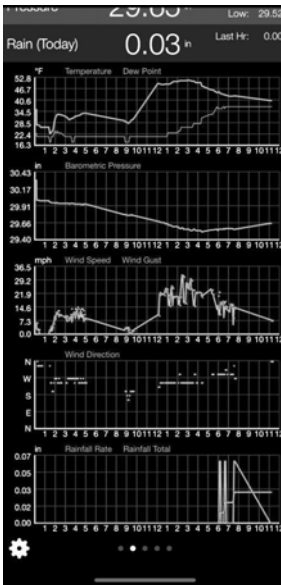

10. Maintenance

1. Clean the rain gauge once every 3 months. Rotate the funnel counter-clockwise and lift to expose the rain gauge mechanism, and clean with a damp cloth. Remove any dirt, debris and insects. If bug infestation is an issue, spray the array lightly with insecticide.

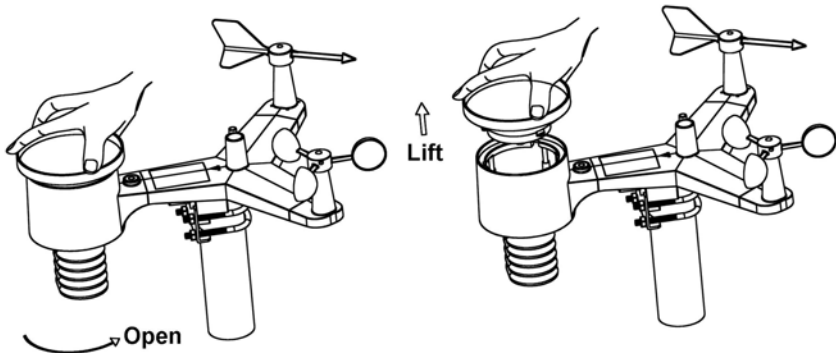

2. Clean the solar radiation sensor and solar panel every 3 months with damp cloth.
3. Replace batteries every 1-2 years. If left in too long, the batteries may leak due to environmental challenges. In harsh environments, inspect the batteries every 3 months (when cleaning the solar panel).
4. When replacing the batteries, apply a corrosion preventive compound on the battery terminals, available at Amazon and most hardware stores.
5. In snowy environments, spray the top of the weather station with anti-icing silicon spray to prevent snow build up.

11. Troubleshooting Guide

Problem	Solution
<p>Outdoor sensor array does not communicate to the display console.</p>	<p>The sensor array may have initiated properly and the data is registered by the console as invalid, and the console must be reset. Press the reset button as described in Section 5.2.</p> <p>With an open ended paperclip, press the reset button for 3 seconds to completely discharge the voltage.</p> <p>Take out the batteries and wait one minute, while covering the solar panel to drain the voltage.</p> <p>Put batteries back in and resync the console with the sensor array about 10 feet away.</p> <p>The LED next to the battery compartment will flash every 16 seconds. If the LED is not flashing every 16 seconds...</p> <p>Replace the batteries in the outside sensor array.</p> <p>If the batteries were recently replaced, check the polarity. If the sensor is flashing every 16 seconds, proceed to the next step.</p> <p>There may be a temporary loss of communication due to reception loss related to interference or other location factors,</p> <p>or the batteries may have been changed in the sensor array and the console has not been reset. The solution may be as simple as powering down and up the console (remove AC power and batteries, wait 10 seconds, and reinsert AC power and batteries).</p>

Problem	Solution
<p>Temperature sensor reads too high in the day time.</p>	<p>Make certain that the sensor array is not too close to heat generating sources or structures, such as buildings, pavement, walls or air conditioning units.</p> <p>Use the calibration feature to offset installation issues related to radiant heat sources. Reference Section 6.7.</p>
<p>Relative pressure does not agree with official reporting station</p>	<p>You may be viewing the absolute pressure, not the relative pressure.</p> <p>Select the relative pressure. Make sure you properly calibrate the sensor to an official local weather station. Reference Section 6.7 for details.</p>
<p>Rain gauge reports rain when it is not raining</p>	<p>An unstable mounting solution (sway in the mounting pole) may result in the tipping bucket incorrectly incrementing rainfall. Make sure you have a stable, level mounting solution.</p>
<p>Data not reporting to Wunderground.com</p>	<ol style="list-style-type: none"> 1. Confirm your password or key is correct. It is the password you registered on Wunderground.com. Your Wunderground.com password cannot begin with a non-alphanumeric character (a limitation of Wunderground.com, not the station). Example, \$oewkrf is not a valid password, but oewkrf\$ is valid. 2. Confirm your station ID is correct. The station ID is all caps, and the most common issue is substituting an O for a 0 (or visa versa). Example, KAZPHOEN11, not KAZPH0EN11 3. Make sure the date and time is correct on the console. If incorrect, you may be reporting old data, not real time data. 4. Make sure your time zone is set properly. If

Problem	Solution
	<p>incorrect, you may be reporting old data, not real time data.</p> <ol style="list-style-type: none"> 5. Check your router firewall settings. The console sends data via Port 80.
No WiFi connection	<ol style="list-style-type: none"> 1. Check for WiFi symbol on the display. If wireless connectivity is successful the WiFi icon  will be displayed in the time field. 2. Make sure your modem WiFi settings are correct (network name, and password). 3. Make sure the console is plugged into AC power. The console will not connect to WiFi when powered by batteries only. 4. The console only supports and connects to 2.4 GHz routers. If you own a 5 GHz router, and it is a dual band router, you will need to disable the 5 GHz band, and enable the 2.4 GHz band. 5. The console does not support guest networks.